

File # 120803-0

No.	PART NAME	STANDARD/SIZE	MATERIAL	QTY	NOTE
1	グリップ付ヘルールキャップ	ISO 2.5S	SUS316L	1	3-005759

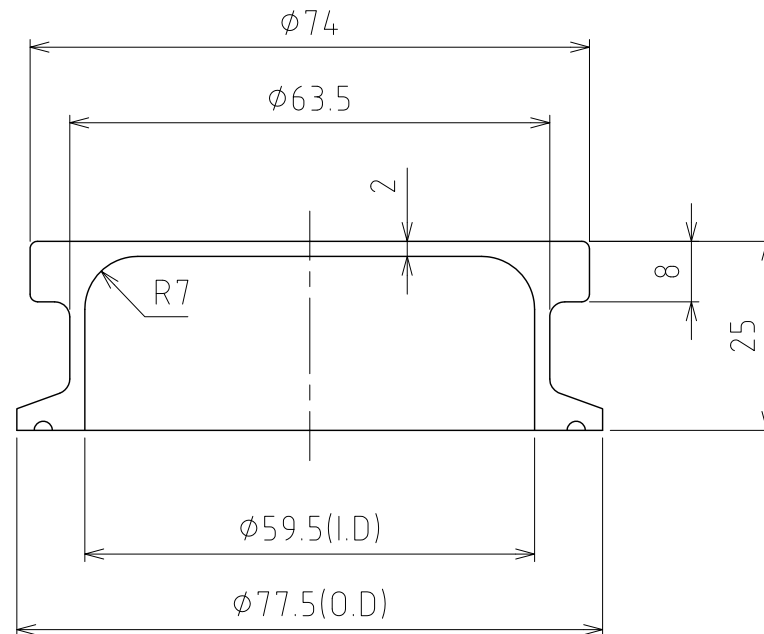
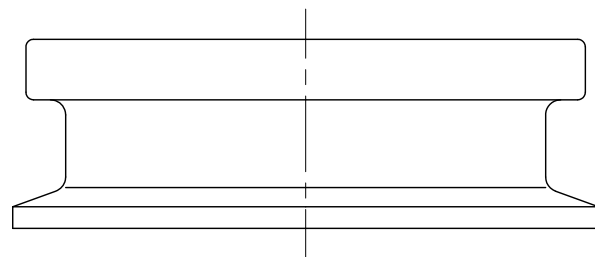
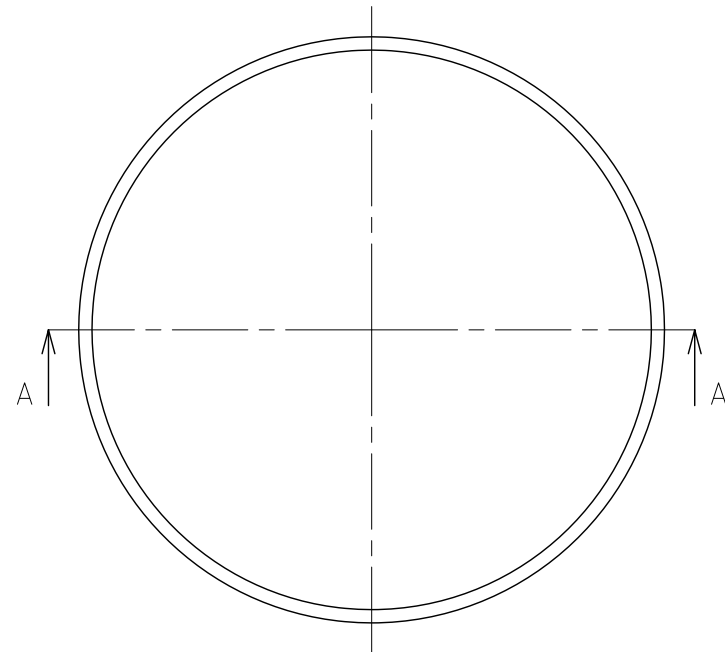

A-A

注記
仕上げ：脱脂洗浄

MARK	DATE	REV	APPROVED
板金溶接組立の寸法許容差は±1%又は5mmの大きい値			
DESIGN	DATE	NAME	グリップ付ヘルールキャップ GC-2.5S
-	2016/03/31	DWG NO.	
DRAWN	DATE	SCALE	3-120803-0
-	-	1:1	
CHECKED	DATE	CUSTOMER	規格図
-	-	SANKO ASTEC INC.	
APPROVED	DATE		
-	-		