

File # 051206-0

No.	PART NAME	STANDARD/SIZE	MATERIAL	QTY	NOTE
1	バケツ用蓋	t1	SUS304	1	
2	コの字取っ手	t1	SUS304	1	

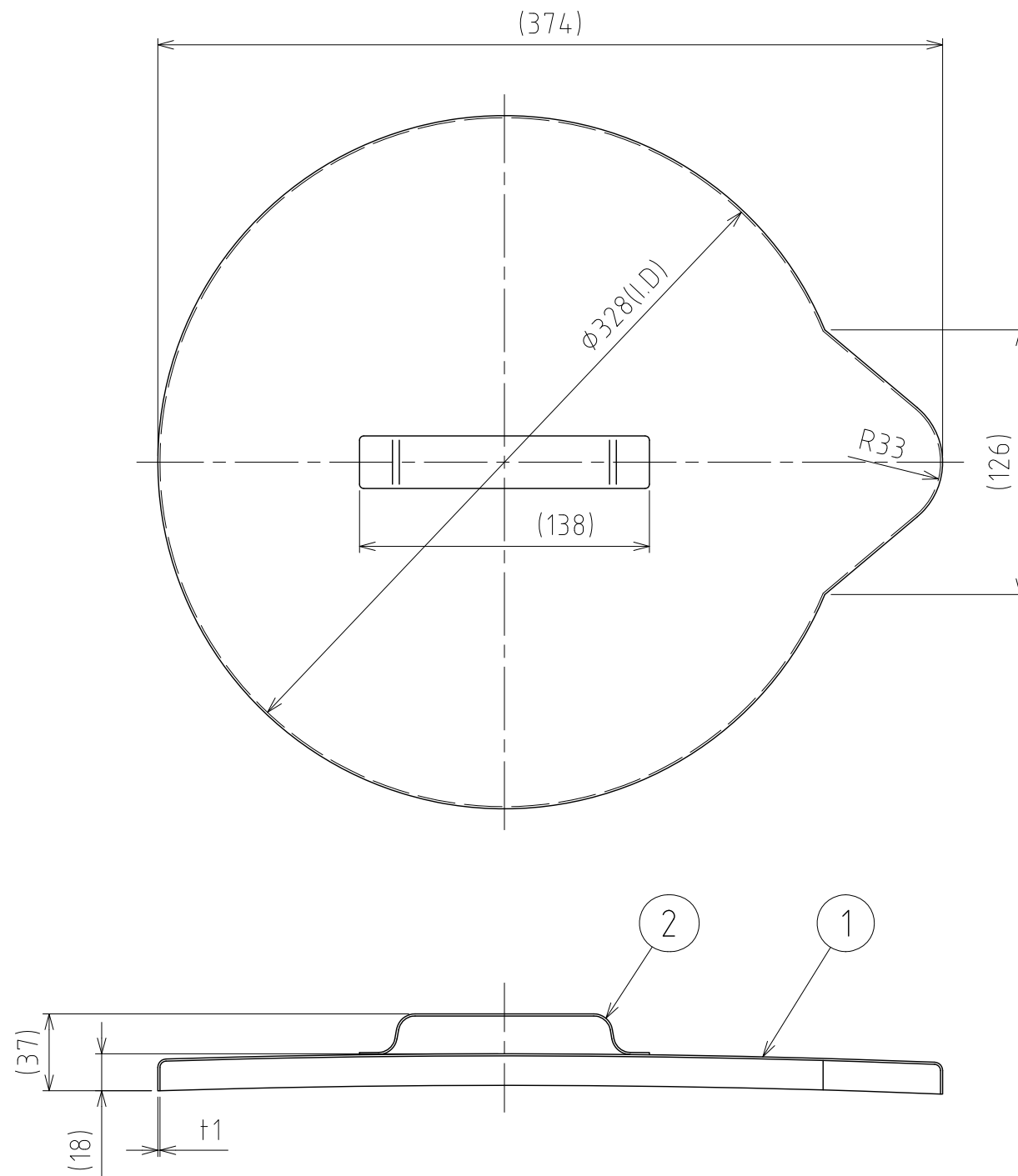

注記
 仕上げ：内外面バフ研磨
 コの字取っ手の取付は、スポット溶接
 重量：0.8kg

MARK	DATE	REV	APPROVED
板金溶接組立の寸法許容差は±1%又は5mmの大きい値			
DESIGN	DATE	NAME	ステンレスバケツ用蓋 BAF-20
-	2016/03/31	DWG NO.	3-051206-0
DRAWN	DATE	SCALE	1:3
-	-	CUSTOMER	規格図
CHECKED	DATE	SANKO ASTEC INC.	
-	-		
APPROVED	DATE		
-	-		