

File # 051203-0

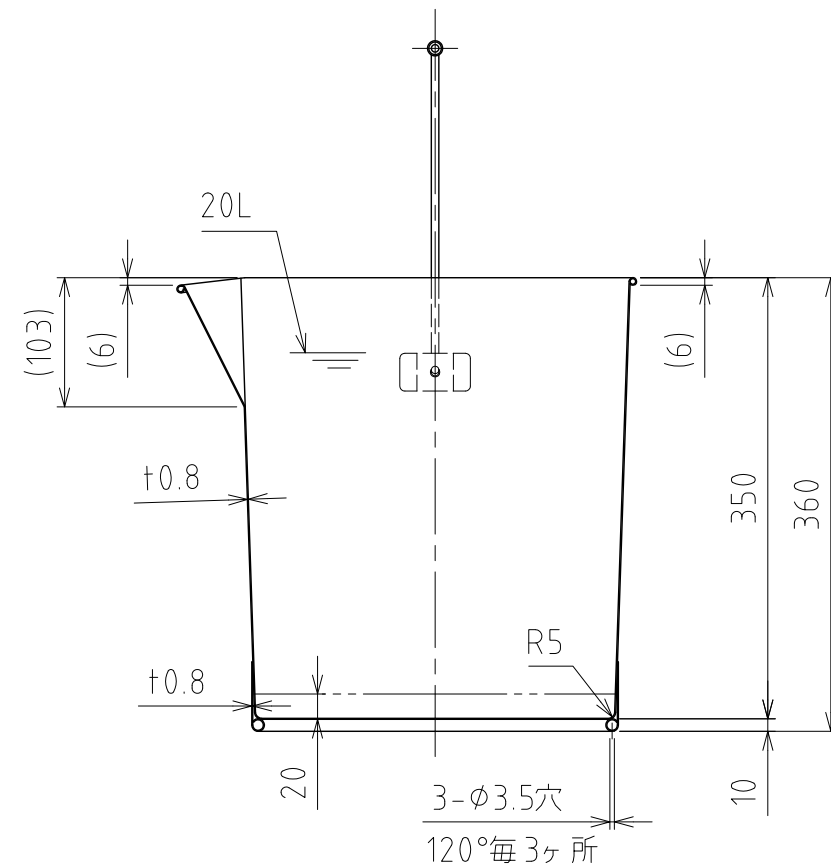
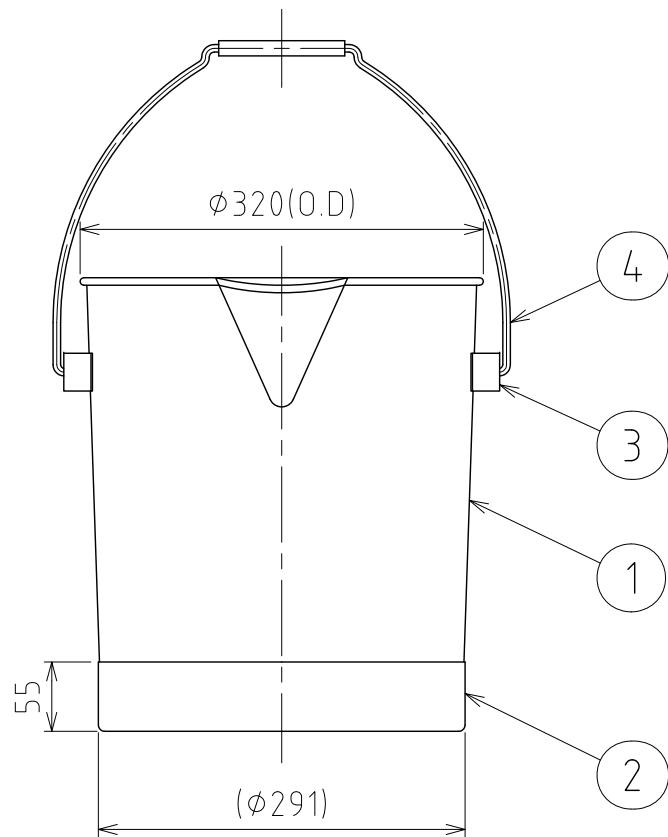
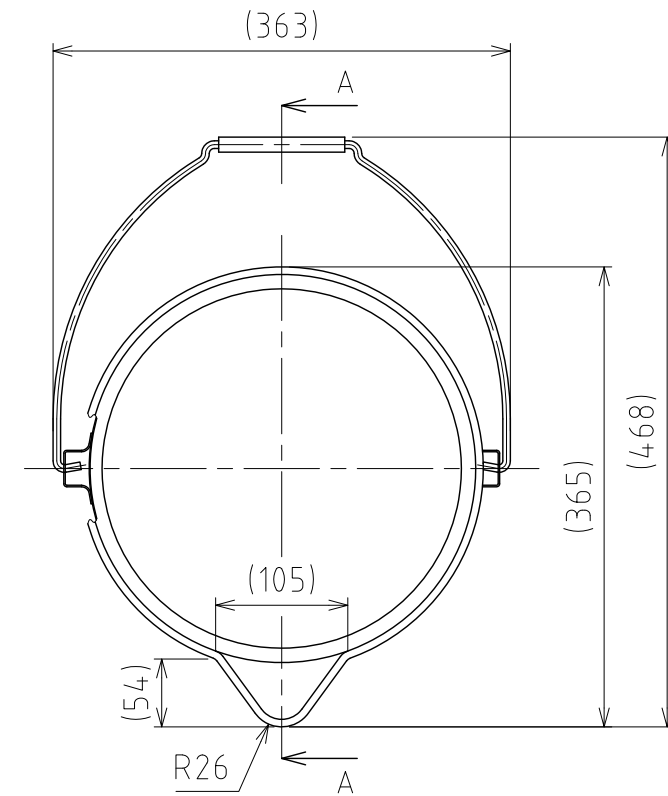

A-A

No.	PART NAME	STANDARD/SIZE	MATERIAL	QTY	NOTE
1	バケツ本体		SUS304	1	
2	袴		SUS304	1	
3	ツル取付座		SUS304	2	
4	ツル		SUS304	1	

注記
 容量：20L
 仕上げ：内外面バフ研磨
 ツル取付座の取付は、スポット溶接
 二点鎖線は、周溶接位置
 重量：約3.4kg

DESIGN	DATE
-	2016/03/31
DRAWN	DATE
-	-
CHECKED	DATE
-	-
APPROVED	DATE
-	-

MARK	DATE	REV	APPROVED
板金溶接組立の寸法許容差は±1%又は5mmの大きい値			
NAME	ステンレスバケツ BA-20		
DWG NO.	3-051203-0		
SCALE	1:6	CUSTOMER	規格図
SANKO ASTEC INC.			