

File # 032010-0

No.	PART NAME	STANDARD/SIZE	MATERIAL	QTY	NOTE
1	容器本体	DTM-CTL-39/本体	SUS304	1	3-005156
2	TM架台	TM-39-DT	SUS304	1	3-005212
3	固定ピン		SUS304	2	4-005116

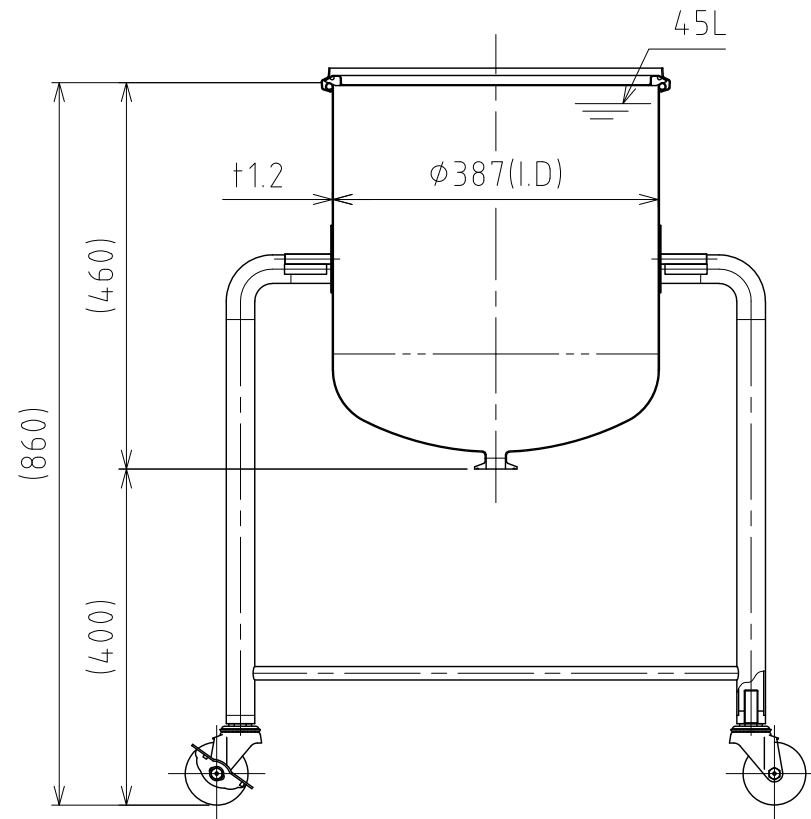
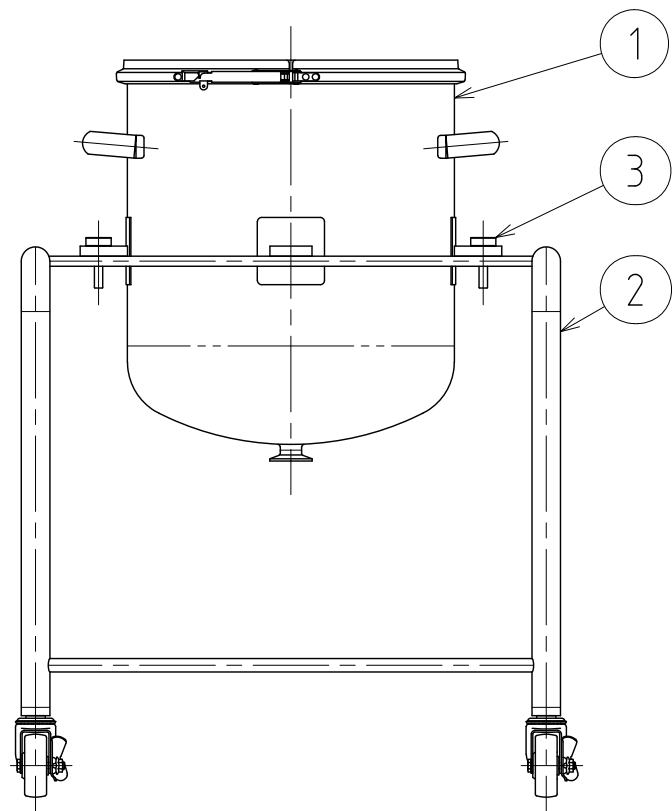
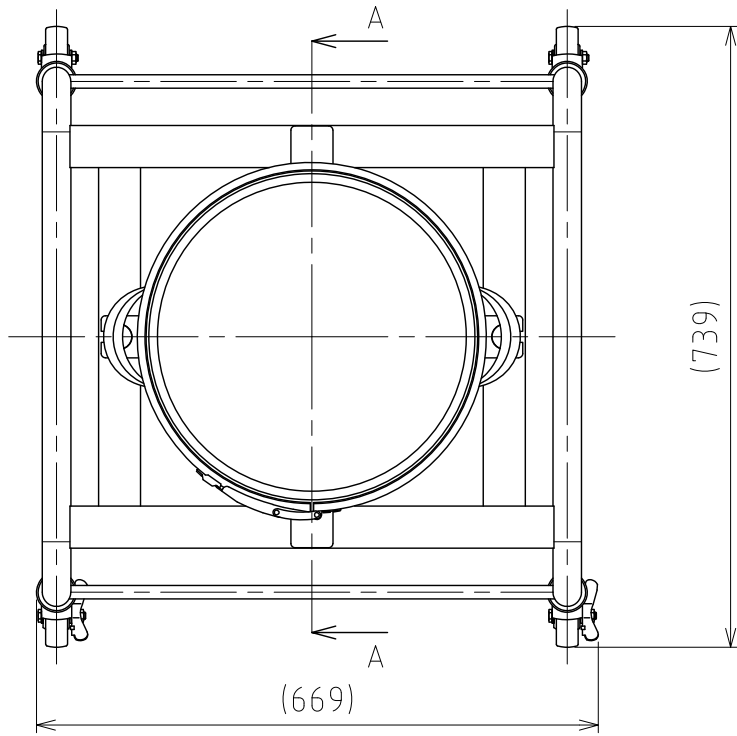

A-A

注記
 容量：45L
 仕上げ：内外面# 320バフ研磨
 ニ点鎖線は、周溶接位置
 使用重量は、容器本体を含み 261kg以下

DESIGN	DATE
-	2016/03/31
DRAWN	DATE
-	-
CHECKED	DATE
-	-
APPROVED	DATE
-	-

MARK	DATE	REV	APPROVED
板金溶接組立の寸法許容差は±1%又は5mmの大きい値			
NAME	架台分離型鏡板容器 DTM-CTL-39		
DWG NO.	3-032010-0		
SCALE	1:9	CUSTOMER	規格図
SANKO ASTEC INC.			