

File # 031601-0

No.	PART NAME	STANDARD/SIZE	MATERIAL	QTY	NOTE
1	容器本体		SUS304	1	
2	ヘルール	ISO 2S $\phi$ 47.8(I.D)	SUS304	1	4-005001
3	取っ手	S	SUS304	2	
4	ストック蓋	S-18 (+0.8)	SUS304	1	

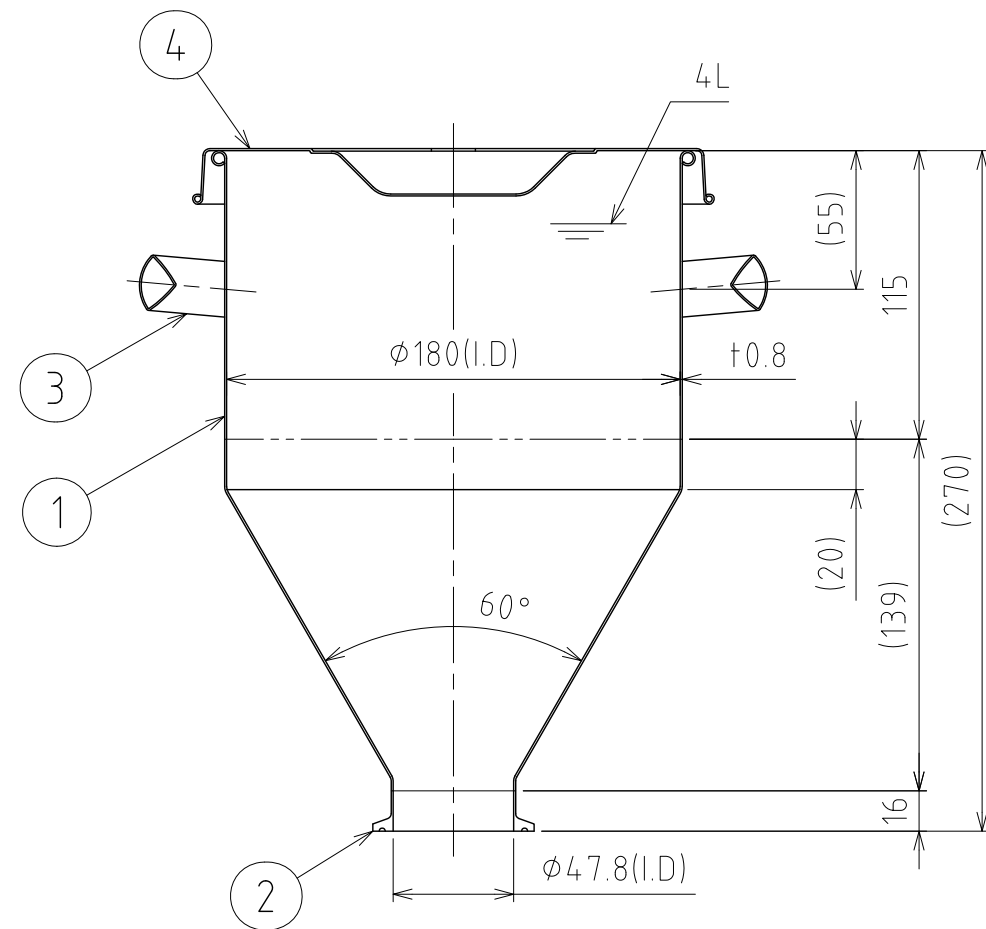
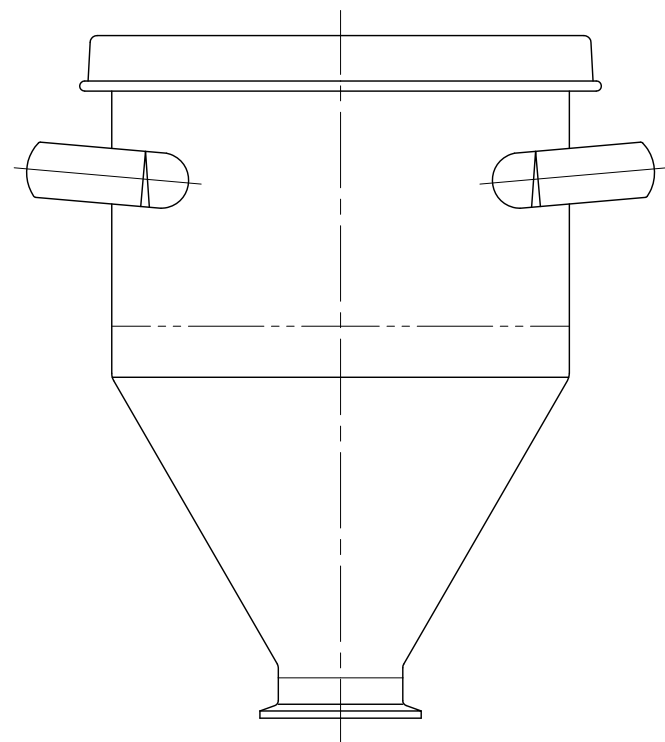
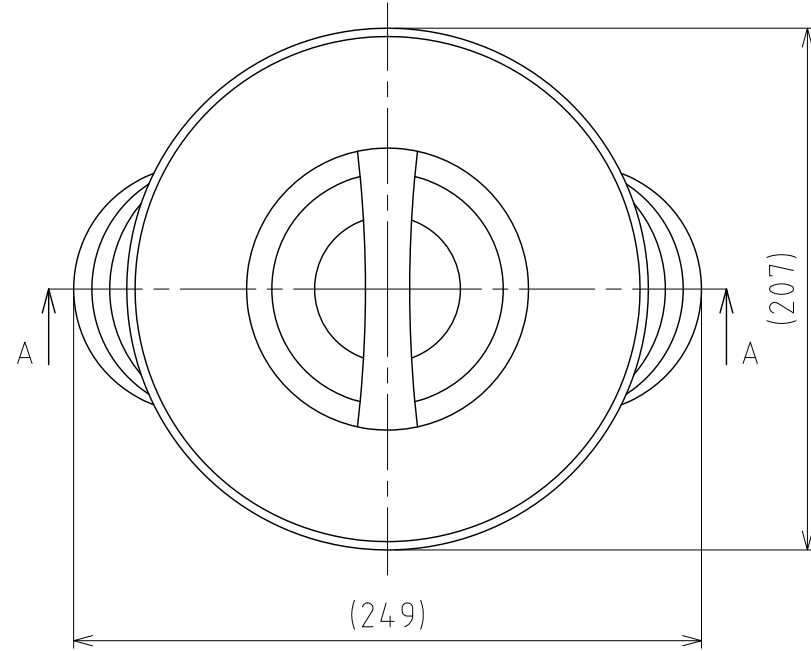

A-A

注記  
 容量：4L  
 仕上げ：内外面# 320バフ研磨  
 取っ手の取付は、スポット溶接  
 二点鎖線は、周溶接位置

DESIGN	DATE
-	2016/03/31
DRAWN	DATE
-	-
CHECKED	DATE
-	-
APPROVED	DATE
-	-

MARK	DATE	REV	APPROVED
板金溶接組立の寸法許容差は±1%又は5mmの大きい値			
NAME	粉体用ホッパー容器（ヘルール接続型） HTFW-ST-18		
DWG NO.	3-031601-0		
SCALE	1:3	CUSTOMER	規格図
<b>SANKO ASTEC INC.</b>			