

File # 030101-0

No.	PART NAME	STANDARD/SIZE	MATERIAL	QTY	NOTE
1	容器本体		SUS304	1	
2	アテ板	40×160×t1.2/R4	SUS304	2	
3	サニタリー取っ手	φ10丸棒	SUS304	2	
4	ストック蓋	S-24 (t0.8)	SUS304	1	

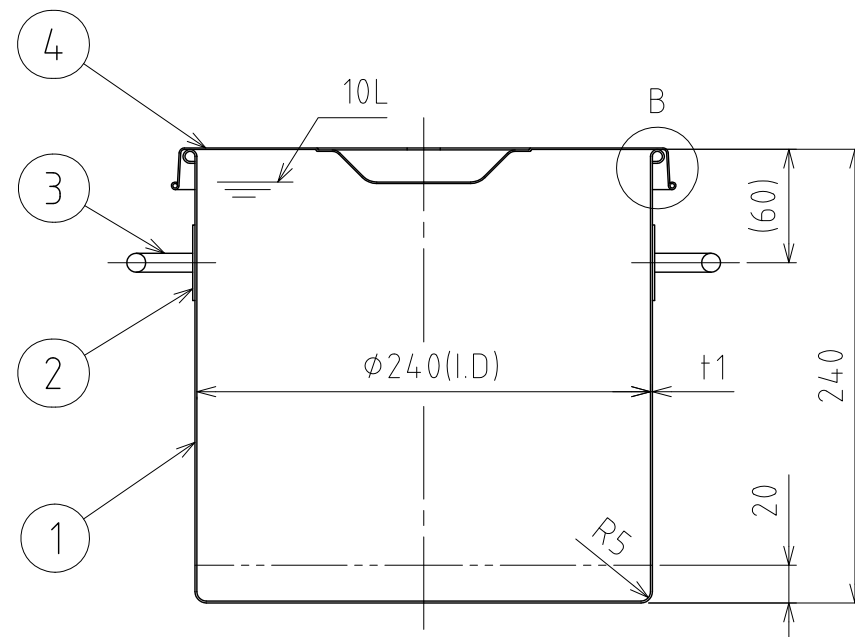
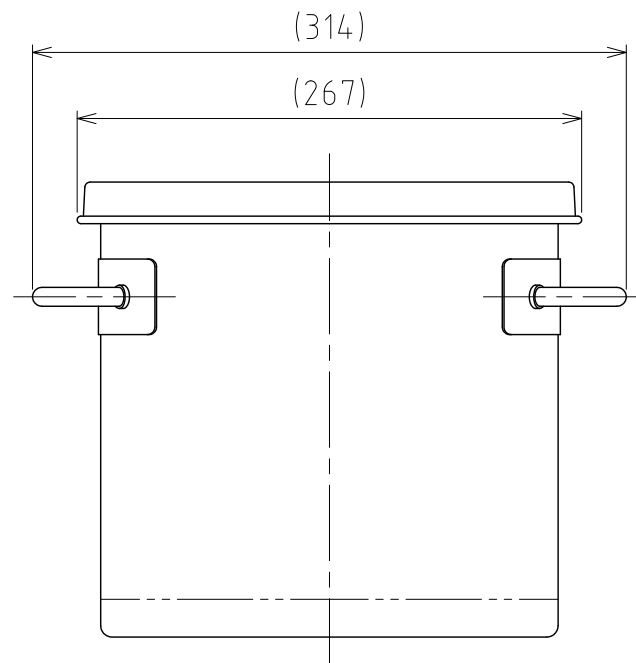
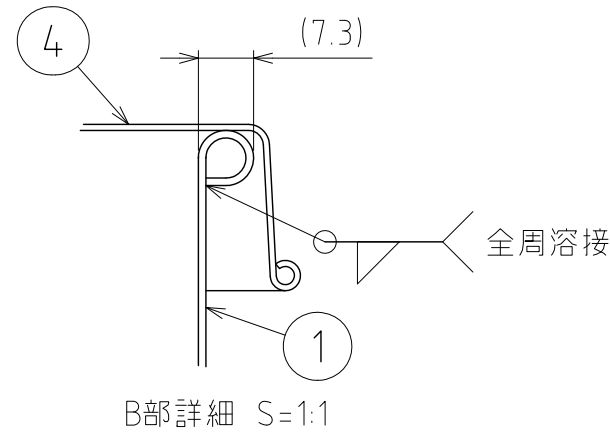
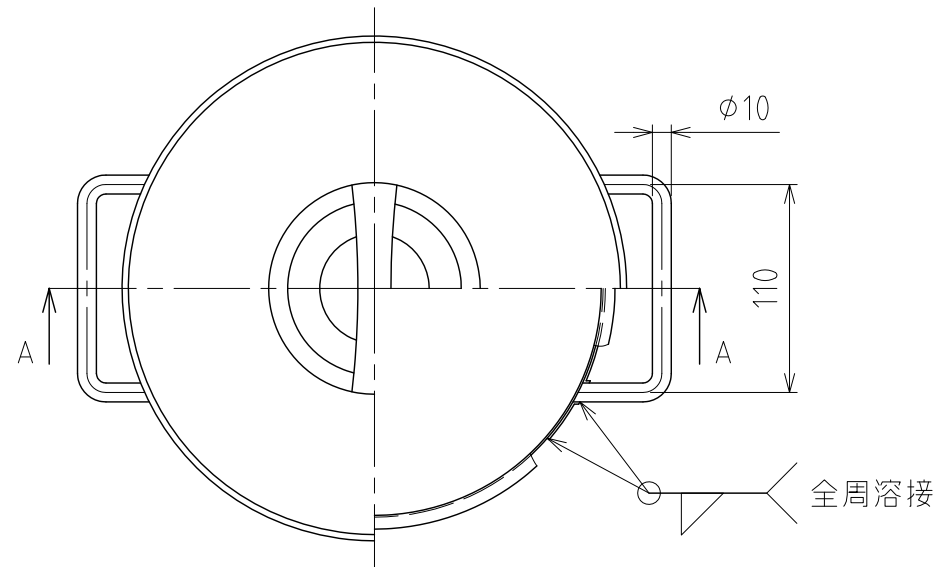

A-A

注記
 容量：10L
 仕上げ：内外面#320バフ研磨
 二点鎖線は、周溶接位置
 重量：約2.7kg

DESIGN	DATE
-	2016/03/31
DRAWN	DATE
-	-
CHECKED	DATE
-	-
APPROVED	DATE
-	-

MARK	DATE	REV	APPROVED
板金溶接組立の寸法許容差は±1%又は5mmの大きい値			
NAME	サニタリー容器 SMA-ST-24		
DWG NO.	3-030101-0		
SCALE	1:4	CUSTOMER	規格図
SANKO ASTEC INC.			