

File # 015106-0

No.	PART NAME	STANDARD/SIZE	MATERIAL	QTY	NOTE
1	容器本体		SUS304	1	
2	ツル取付座	TU-33用	SUS304	2	
3	ツル	TU-33用	SUS304	1	
4	ストック蓋	S-33 (t0.8)	SUS304	1	

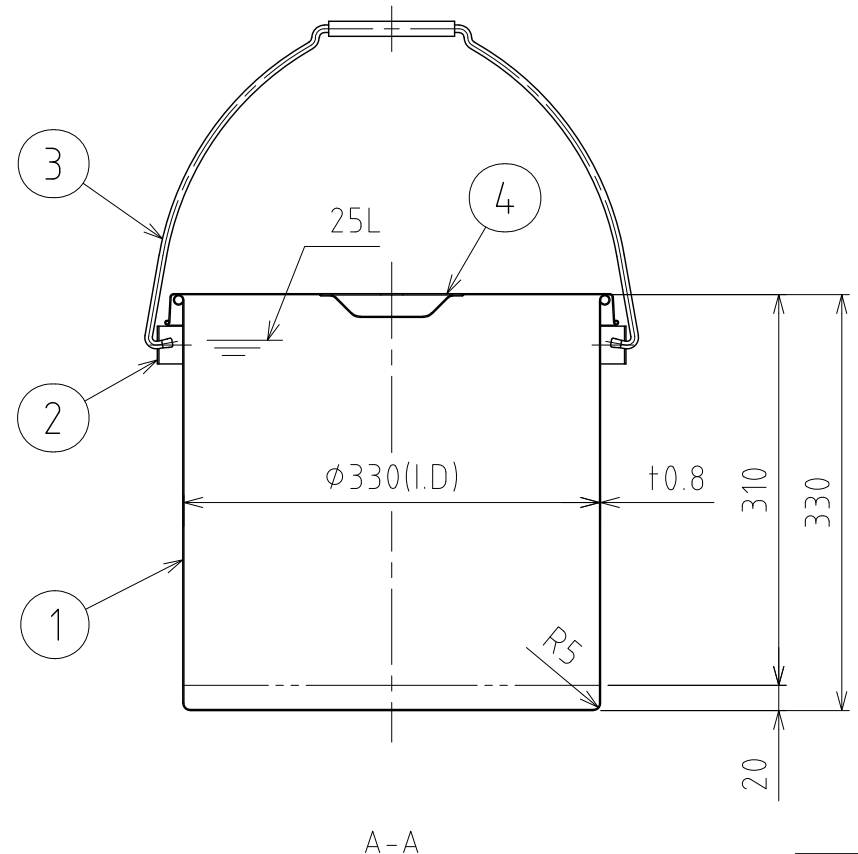
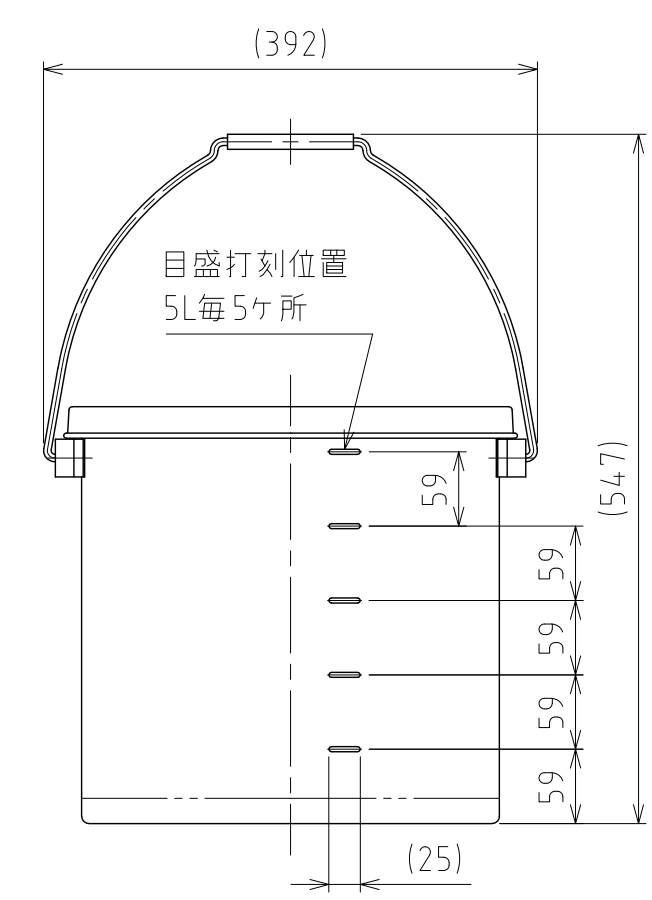
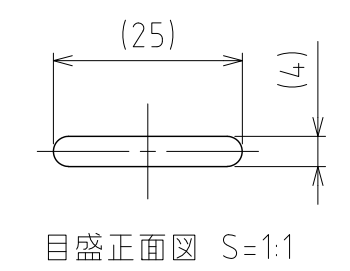
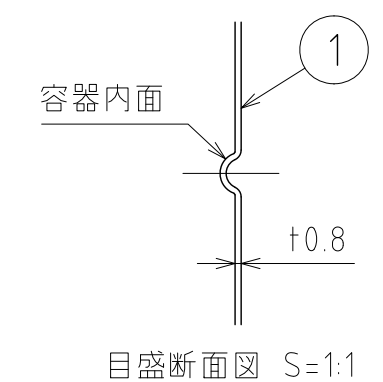
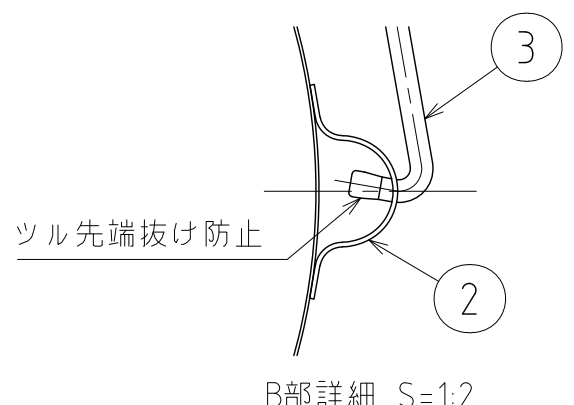
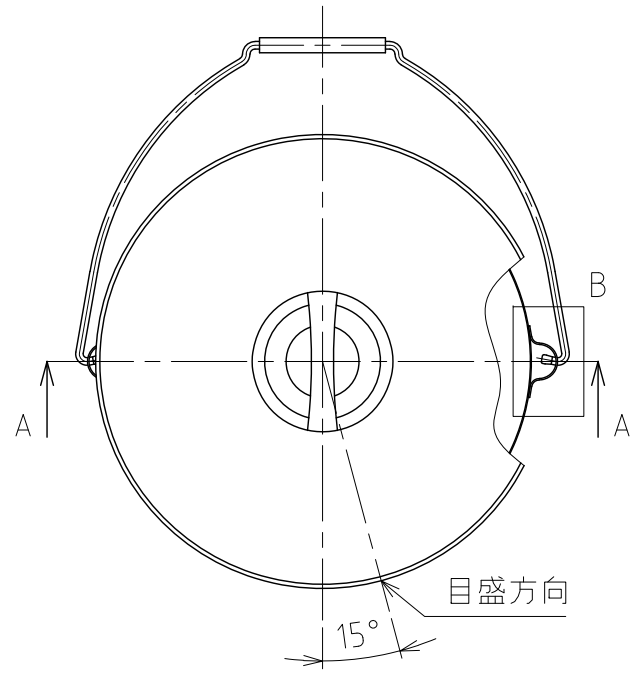

注記
 容量：25L
 仕上げ：内外面# 320バフ研磨
 ツル取付座の取付は、スポット溶接
 二点鎖線は、周溶接位置
 重量：約3.8kg

DESIGN	DATE
-	2022/03/31
DRAWN	DATE
-	-
CHECKED	DATE
-	-
APPROVED	DATE
-	-

MARK	DATE	REV	APPROVED
板金溶接組立の寸法許容差は±1%又は5mmの大きい値			
NAME	目盛付ツル付スタンダード容器 TU-ST-M-33/ストック蓋付		
DWG NO.	3-015106-0		
SCALE	1:6	CUSTOMER	規格図

SANKO ASTEC INC.