

No.	PART NAME	STANDARD/SIZE	MATERIAL	QTY	NOTE
1	容器本体		SUS304	1	
2	取っ手	M	SUS304	2	
3	ストック蓋	S-33 (+0.8)	SUS304	1	

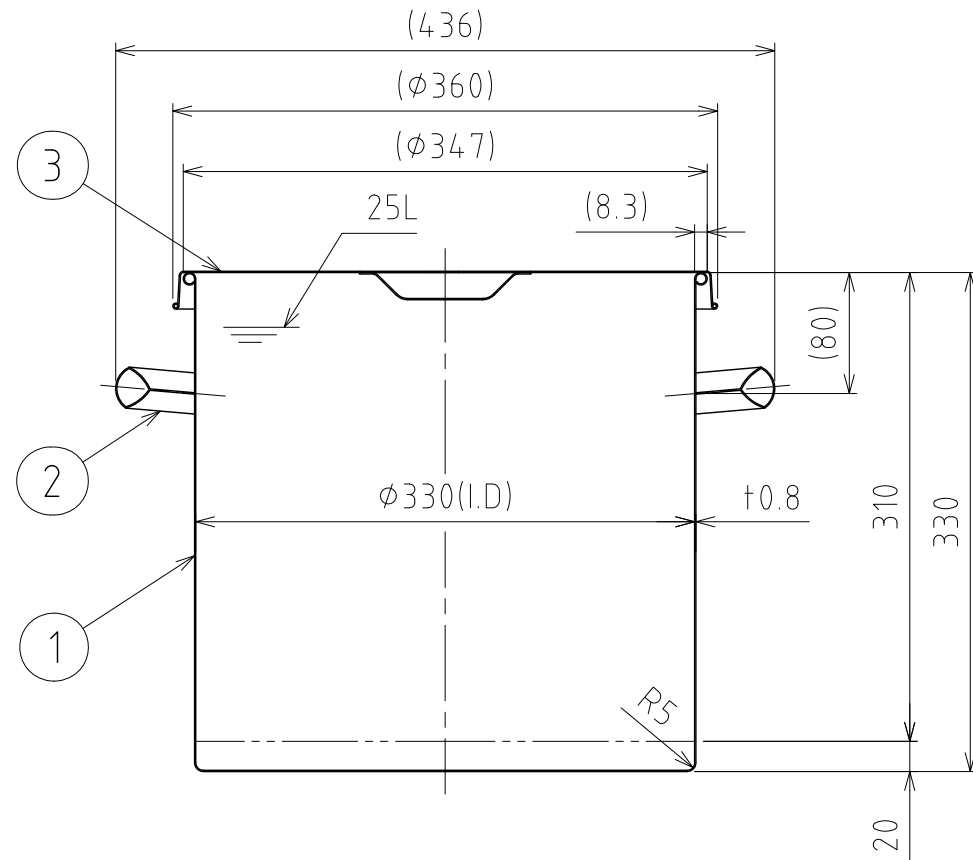
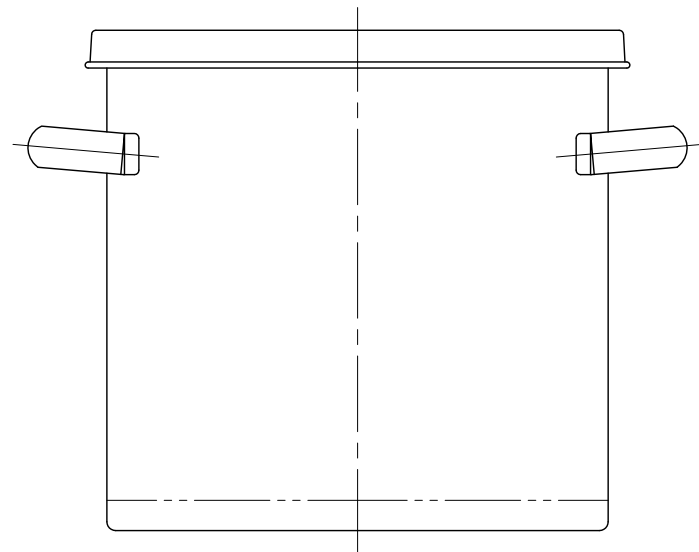
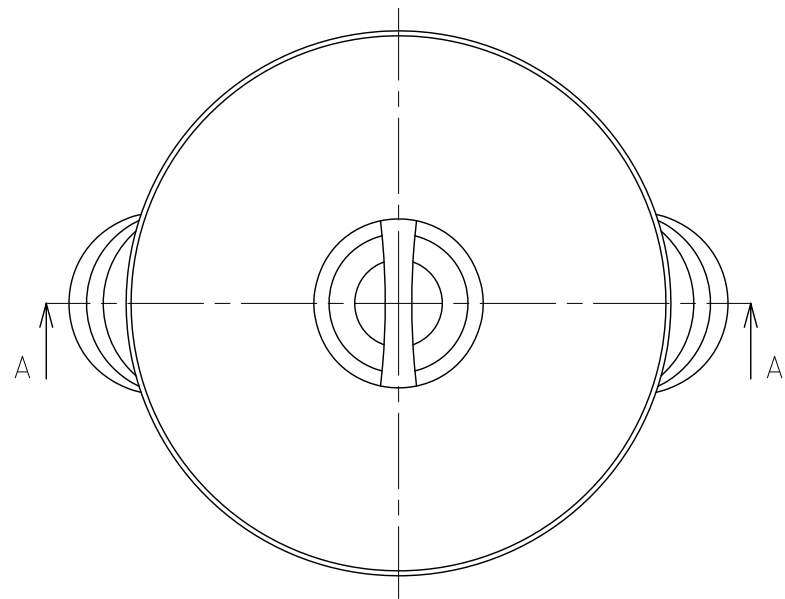

A-A

注記
 容量：25L
 仕上げ：内外面# 320バフ研磨
 取っ手の取付は、スポット溶接
 二点鎖線は、周溶接位置
 重量：約3.7kg

DESIGN	DATE
-	2016/03/31
DRAWN	DATE
-	-
CHECKED	DATE
-	-
APPROVED	DATE
-	-

MARK	DATE	REV	APPROVED
板金溶接組立の寸法許容差は±1%又は5mmの大きい値			
NAME	スタンダード容器 ST-33/ストック蓋付		
DWG NO.	3-010106-0		
SCALE	1:5	CUSTOMER	規格図
SANKO ASTEC INC.			