

File #	131507-0				
No.	PART NAME	STANDARD/SIZE	MATERIAL	QTY	NOTE
1	ヘルール (A)	3A 3/4"	SUS316L	1	
2	ヘルール (B)	ISO 10A	SUS316L	1	

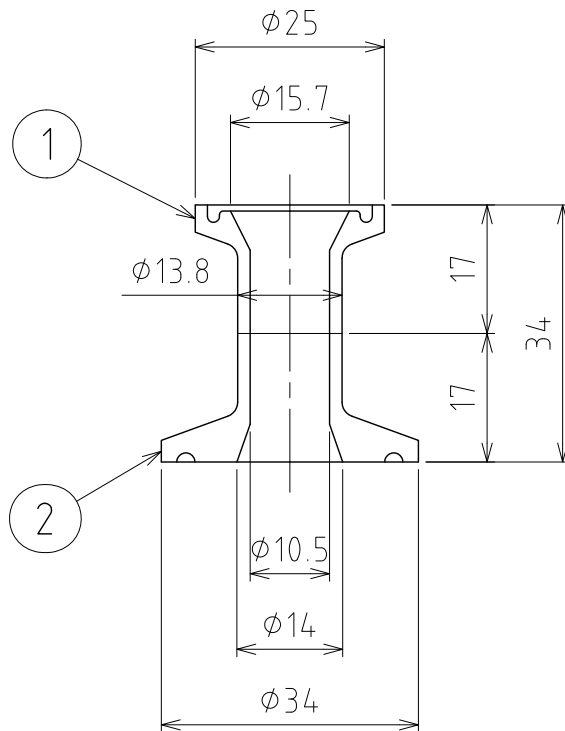

注記

仕上げ：内外面バフ研磨＋内面電解研磨

MARK	DATE	REV	APPROVED
板金溶接組立の寸法許容差は±1%又は5mmの大きい値			

DESIGN	DATE	NAME	3A-ISOヘルール変換アダプター		
-	2016/03/31		3/4" x 10A / SUS316L		
DRAWN	DATE	DWG NO.	4-131507-0		
-	-				
CHECKED	DATE	SCALE	1:1	CUSTOMER	規格図
-	-				
APPROVED	DATE	SANKO ASTEC INC.			
-	-				