

File # 051408-0

No.	PART NAME	STANDARD/SIZE	MATERIAL	QTY	NOTE
1	カップ	t1.5	SUS304	1	
2	アテ板	t1.2×45×50	SUS304	1	
3	化粧パイプ	φ25(t1)	SUS304	1	
4	円板	φ25×t1	SUS304	1	

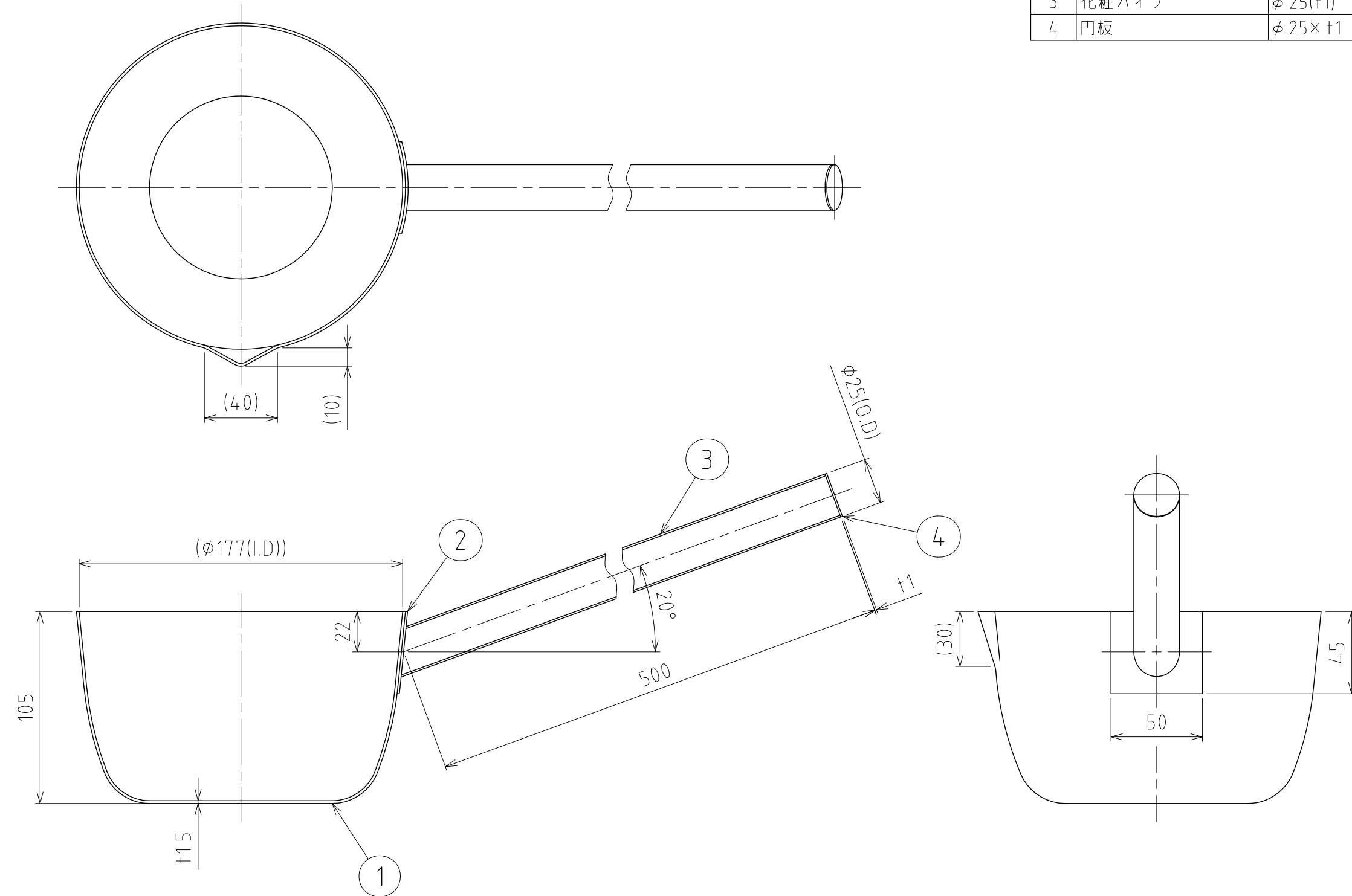

注記
 容量：2L
 仕上げ：内外面バフ研磨
 重量：0.9kg

MARK	DATE	REV	APPROVED
板金溶接組立の寸法許容差は±1%又は5mmの大きい値			
DESIGN	DATE	NAME	ステンレス柄杓 HS-2-500
-	2016/03/31	DWG NO.	
DRAWN	DATE	SCALE	1:2.5 CUSTOMER 規格図
-	-	APPROVED	
CHECKED	DATE	SANKO ASTEC INC.	
-	-		
APPROVED	DATE		
-	-		